

HK2020

Drawn cup needle roller bearing open end

Schaeffler ID:
0000361960000

Drawn cup needle roller bearings with
open ends HK, to DIN 618/ISO 3245

Technical information

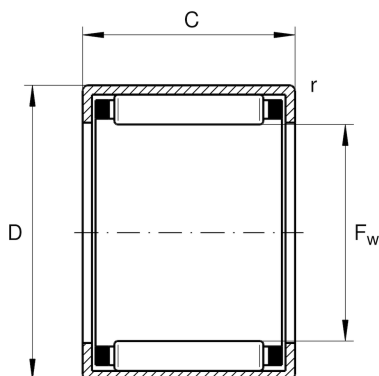

Main Dimensions & Performance Data

F_w	20 mm	Under roller diameter
D	26 mm	Outside diameter
C	20 mm	Width
C_r	15,700 N	Basic dynamic load rating, radial
C_{0r}	26,000 N	Basic static load rating, radial
C_{ur}	3,600 N	Fatigue load limit, radial
n_G	12,700 1/min	Limiting speed
$n_{G \text{ Grease}}$	7,600 1/min	Limiting speed for grease lubrication
n_{gr}	9,300 1/min	Reference speed
	23.535 g	Weight

Dimensions

	SD20X26X4	Sealing ring
C_1	20 mm	Width, outer ring
r_{min}	0.8 mm	Minimum chamfer dimension
	G20X26X4	Sealing ring 2
	LR17X20X20,5	Suitable inner rings LR
	IR17X20X20-XL	Suitable inner rings IR

Temperature range

T_{min}	-30 °C	Operating temperature min.
T_{max}	140 °C	Operating temperature max.